

 **ALARKO**

Panel Radiator

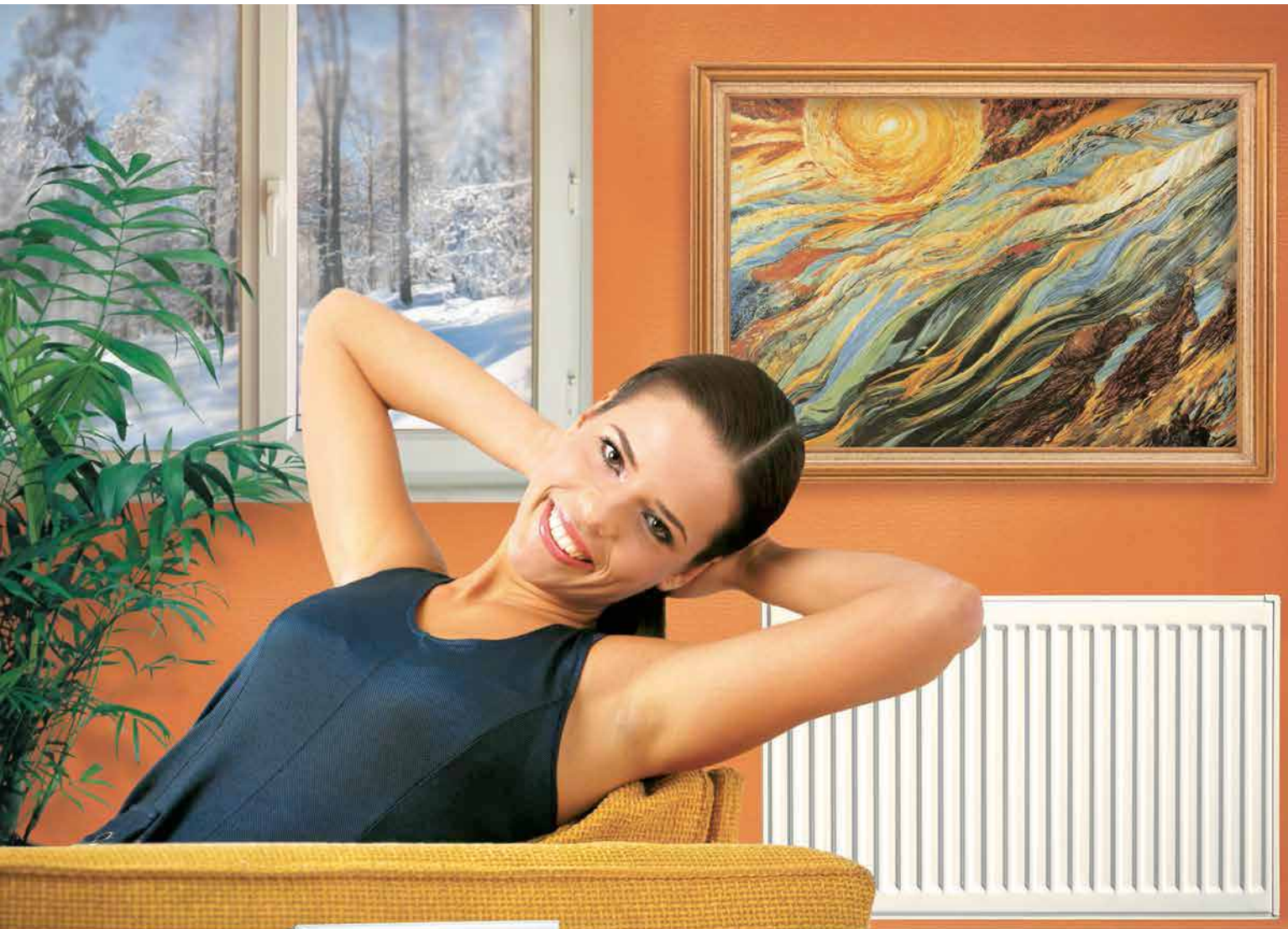

THE ART OF HEATING...



EN EURONORM
442

TESTED
TO
10
BAR

The line which reaches to 21'st Century in panel radiator...



RICH ALTERNATIVES

Alarko steel panel radiators provide possibility of selection of radiators which have dimensions most suitable to the heat requirement of environment and to the architectural and decorative design with their types produced in 6 different heights between 300-900 mm. and 21 different lengths between 400-1.800 mm. with an increment of 100 mm. and 2.000-3.000 mm. with an increment of 200 mm. They are coated in white colour (RAL 9010) as standard. Coating can be made in desired colours for special cumulative orders.



TYPE 10 P

Standard width: a= 48 mm.

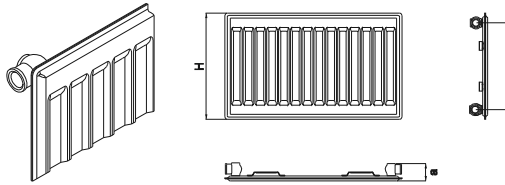

TYPE 11 PK

Standard width: a= 48 mm.

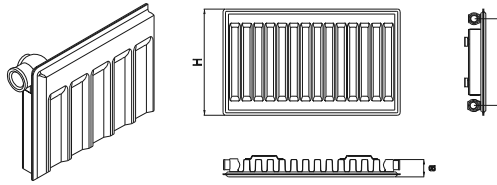

TYPE 21 PKP

Standard width: a= 67 mm.

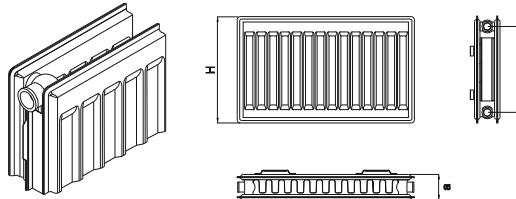

TYPE 22 PKKP

Standard width: a= 105 mm.

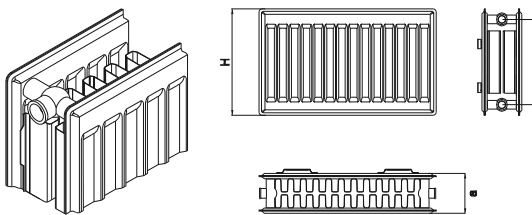

TYPE 33 PKPKP

Standard width: a= 160.5 mm.

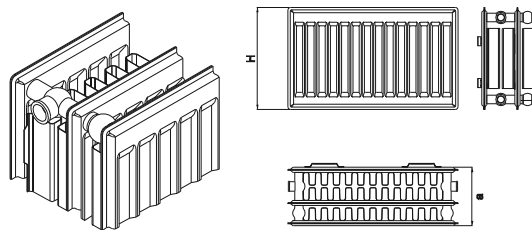

SUSPENSION BRACKET DIMENSIONS

For lengths between 400-1700 mm.

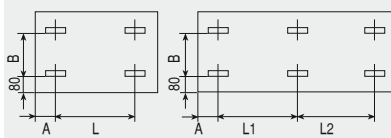

RADIATOR HEIGHT	B
300	115
400	215
500	315
600	415
750	565
900	715

TYPE	DIMENSIONS (mm)		WEIGHT (kg/m)	WATER CONTENT (Lt/m)
	HEIGHT (H)	A		
TYPE 10 P	300	245	6,2	1,8
	400	345	8,1	2,1
	500	445	10,0	2,5
	600	545	11,9	2,8
	750	695	14,7	3,4
TYPE 11 PK	300	245	7,9	1,8
	400	345	11,3	2,1
	500	445	14,1	2,5
	600	545	17,2	2,8
	750	695	21,3	3,4
TYPE 21 PKP	300	245	13,9	3,6
	400	345	18,2	4,2
	500	445	21,9	5,0
	600	545	26,8	5,6
	750	695	33,7	6,8
TYPE 22 PKKP	300	245	40,7	8,0
	300	245	16,1	3,6
	400	345	20,6	4,2
	500	445	25,6	5,0
	600	545	30,7	5,6
TYPE 33 PKPKP	750	695	38,5	6,8
	900	845	46,6	8,0
	300	245	24,1	5,4
	400	345	30,8	6,3
	500	445	38,4	7,5
TYPE 33 PKPKP	600	545	50,2	8,4
	750	695	58,9	10,2
	900	845	69,9	12,0

Contact Alrako Carrier for the net weight information of the compact valve types or standard types with different lengths.

MOUNTING BRACKET DIMENSIONS

300 mm HEIGHT The mounting bracket can be installed either on the wide or the narrow side, depending on the installation requirements.

400-500-600-750-900 mm HEIGHT

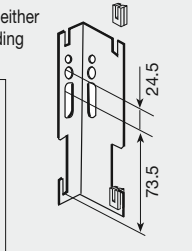
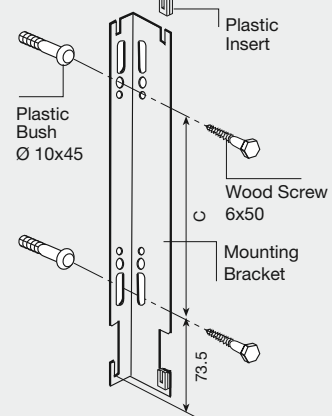

RADIATOR HEIGHT	C
400	92.51
500	92.52
600	92.5
750	442.5
900	592.5

All the dimension are given in mm.

RADIATOR LENGTH		400	500	600	700	800	900	1000	1100	1200	1300	1400	1500	1600	1700
Type: 10-20-21-22-33 KV 20-21-22-33	L	133.3	233.3	333.3	433.3	533.3	633.3	733.3	833.3	933.3	1033.3	1133.3	1233.3	1333.3	1433.3
	A	133.3	133.3	133.3	133.3	133.3	133.3	133.3	133.3	133.3	133.3	133.3	133.3	133.3	133.3
Type: 11 - KV 11	L	167	267	367	467	567	667	767	867	967	1067	1167	1267	1367	1467
	A	116.5	116.5	116.5	116.5	116.5	116.5	116.5	116.5	116.5	116.5	116.5	116.5	116.5	116.5
Type: KV 10	L	68	168	268	368	468	568	668	768	868	968	1068	1168	1268	1368
	A	168	166	166	166	166	166	166	166	166	166	166	166	166	166

RADIATOR LENGTH		1800	2000	2200	2400	2600	2800	3000
Type: 10-20-21-22-33 KV 20-21-22-33	L1	766.7	866.7	966.7	1066.7	1166.7	1266.7	1366.7
	L2	766.7	866.7	966.7	1066.7	1166.7	1266.7	1366.7
	A	133.3	133.3	133.3	133.3	133.3	133.3	133.3
Type: 11 - KV 11	L1	800	900	1000	1100	1200	1300	1400
	L2	766.5	866.5	966.5	1066.5	1166.5	1266.5	1366.5
	A	116.5	116.5	116.5	116.5	116.5	116.5	116.5
Type: KV 10	L1	734	834	934	1034	1134	1234	1334
	L2	734	834	934	1034	1134	1234	1334
	A	166	166	166	166	166	166	166

KV: Compact valve type



RADIATORS SUPPLIED WITH COMPACT VALVE

Alarko steel panel radiators can also be supplied with compact valve ensuring piping connection from the bottom side. This type of radiator provides savings in heating costs, when equipped with a thermostatic regulator.

HIGH HEATING EFFICIENCY

Heating surfaces are increased by their special profile, water circulation channels with 33,3 mm pitch and high convectors directly welded onto these channels. They heat environment rapidly since their water content is little and heat outputs are high. More output is achieved from a smaller radiator.

CONVERSION INFORMATION: The values on the table are prepared for mean water temperatures 70°C and 80°C. For different operating temperature conditions, you can use "Panel Radiator Thermal Conversion Calculation Programme" under the "Product Selection" section in the Alarko Carrier website.



PANEL RADIATORS HEAT OUTPUT (kcal/h) - DIN EN 442																	
TYPE	Height (mm)	75/65 °C (Mean Water Temperature 70 °C)								90/70 °C (Mean Water Temperature 80 °C)							
		ROOM TEMPERATURE (°C)								ROOM TEMPERATURE (°C)							
		10	12	15	18	20	22	24	26	10	12	15	18	20	22	24	26
10-P	300	337	323	302	281	267	254	241	227	411	396	374	352	337	323	309	295
	400	430	412	385	358	341	323	306	289	524	505	477	449	430	412	394	376
	500	522	500	467	434	413	392	371	350	637	614	579	545	522	500	478	456
	600	617	590	551	512	487	462	437	412	754	726	685	644	617	590	564	538
	750	762	728	679	631	599	568	537	507	932	898	846	795	762	728	696	663
	900	916	875	816	757	719	681	644	607	1.123	1.081	1.018	956	916	875	836	796
11-PK	300	545	521	486	451	428	406	384	362	667	642	605	569	545	521	497	474
	400	703	672	627	582	553	524	496	467	861	829	781	734	703	672	642	612
	500	854	817	762	708	673	637	603	569	1.046	1.007	949	892	854	817	780	744
	600	1.000	957	892	829	788	747	706	666	1.223	1.178	1.110	1.044	1.000	957	914	871
	750	1.206	1.154	1.077	1.001	951	902	853	805	1.475	1.420	1.339	1.259	1.206	1.154	1.103	1.052
	900	1.401	1.341	1.252	1.164	1.106	1.049	992	937	1.712	1.649	1.555	1.462	1.401	1.341	1.281	1.222
21-PKP	300	786	751	700	649	616	583	551	519	966	930	875	821	786	751	717	683
	400	1.002	958	893	828	786	744	703	663	1.231	1.184	1.115	1.047	1.002	958	914	871
	500	1.203	1.150	1.072	995	944	894	845	797	1.476	1.420	1.337	1.256	1.203	1.150	1.097	1.046
	600	1.389	1.329	1.239	1.150	1.092	1.035	978	923	1.703	1.639	1.544	1.451	1.389	1.329	1.268	1.209
	750	1.644	1.572	1.466	1.363	1.294	1.227	1.160	1.095	2.011	1.936	1.825	1.716	1.644	1.572	1.501	1.432
	900	1.874	1.793	1.673	1.556	1.478	1.402	1.326	1.252	2.290	2.205	2.079	1.956	1.874	1.793	1.713	1.634
22-PKPK	300	1.047	1.001	933	865	821	778	735	693	1.286	1.238	1.165	1.094	1.047	1.001	955	910
	400	1.341	1.282	1.195	1.109	1.053	997	942	888	1.646	1.584	1.492	1.401	1.341	1.282	1.224	1.166
	500	1.617	1.546	1.441	1.338	1.270	1.203	1.137	1.072	1.983	1.909	1.798	1.689	1.617	1.546	1.476	1.407
	600	1.877	1.795	1.674	1.554	1.476	1.398	1.322	1.247	2.301	2.214	2.086	1.960	1.877	1.795	1.714	1.633
	750	2.241	2.143	1.999	1.857	1.764	1.672	1.581	1.491	2.743	2.641	2.489	2.339	2.241	2.143	2.047	1.951
	900	2.575	2.463	2.298	2.136	2.030	1.924	1.820	1.718	3.149	3.032	2.858	2.687	2.575	2.463	2.353	2.244
33-PKPKPKP	300	1.539	1.471	1.370	1.271	1.207	1.143	1.079	1.017	1.891	1.819	1.713	1.608	1.539	1.471	1.404	1.337
	400	1.949	1.863	1.736	1.611	1.529	1.448	1.368	1.290	2.393	2.303	2.169	2.036	1.949	1.863	1.778	1.694
	500	2.334	2.231	2.079	1.930	1.832	1.735	1.640	1.546	2.864	2.756	2.596	2.438	2.334	2.231	2.129	2.029
	600	2.699	2.581	2.405	2.233	2.120	2.008	1.898	1.790	3.311	3.186	3.001	2.819	2.699	2.581	2.463	2.348
	750	3.211	3.071	2.863	2.658	2.524	2.392	2.261	2.132	3.936	3.788	3.569	3.353	3.211	3.071	2.932	2.794
	900	3.688	3.527	3.289	3.055	2.902	2.750	2.600	2.452	4.518	4.349	4.098	3.851	3.688	3.527	3.368	3.211

PANEL RADIATORS HEAT OUTPUT (Watt) - DIN EN 442																	
TYPE	Height (mm)	75/65 °C (Mean Water Temperature 70 °C)								90/70 °C (Mean Water Temperature 80 °C)							
		ROOM TEMPERATURE (°C)								ROOM TEMPERATURE (°C)							
		10	12	15	18	20	22	24	26	10	12	15	18	20	22	24	26
10-P	300	392	376	351	327	311	295	280	264	477	460	434	409	392	376	359	343
	400	500	479	447	416	396	376	356	336	610	587	554	522	500	479	458	437
	500	607	581	543	505	480	455	431	407	741	714	673	634	607	581	556	530
	600	717	686	641	596	566	537	508	479	876	844	796	749	717	686	656	626
	750	885	847	790	734	697	661	625	589	1.084	1.044	984	924	885	847	809	771
	900	1.065	1.018	949	881	836	792	748	706	1.306	1.257	1.184	1.112	1.065	1.018	972	926
11-PK	300	633	606	565	524	498	472	446	421	776	747	704	661	633	606	578	551
	400	817	782	729	677	643	609	576	544	1.001	963	908	853	817	782	746	711
	500	993	950	886	823	782	741	701	661	1.216	1.171	1.103	1.037	993	950	907	865
	600	1.163	1.112	1.038	964	916	868	821	775	1.423	1.370	1.291	1.214	1.163	1.112	1.062	1.013
	750	1.403	1.342	1.252	1.164	1.106	1.049	992	936	1.715	1.651	1.557	1.464	1.403	1.342	1.282	1.223
	900	1.629	1.559	1.455	1.353	1.286	1.220	1.154	1.089	1.991	1.917	1.808	1.700	1.629	1.559	1.490	1.421
21-PKP	300	914	874	814	755	716	678	640	603	1.124	1.081	1.018	955	914	874	833	794
	400	1.165	1.114	1.038	963	914	866	818	771	1.431	1.377	1.297	1.218	1.165	1.114	1.063	1.013
	500	1.398	1.337	1.246	1.157	1.098	1.040	983	927	1.716	1.651	1.555	1.461	1.398	1.337	1.276	1.216
	600	1.616	1.545	1.440	1.337	1.270	1.203	1.138	1.073	1.980	1.906	1.796	1.687	1.616	1.545	1.475	1.406
	750	1.911	1.828	1.705	1.584	1.505	1.427	1.349	1.273	2.339	2.252	2.122	1.995	1.911	1.828	1.746	1.665
	900	2.179	2.085	1.946	1.809	1.719	1.630	1.542	1.456	2.663	2.564	2.418	2.274	2.179	2.085	1.992	1.900
22-PKPK	300	1.218	1.164	1.084	1.006	955	904	854	805	1.496	1.439	1.355	1.272	1.218	1.164	1.111	1.058
	400	1.560	1.491	1.389	1.289	1.224	1.159	1.096	1.033	1.914	1.842	1.735	1.629	1.560	1.491	1.423	1.356
	500	1.880	1.798	1.676	1.556	1.477	1.399	1.323	1.247	2.306	2.219	2.091	1.964	1.880	1.798	1.716	1.635
	600	2.183	2.087	1.946	1.807	1.716	1.626	1.537	1.450	2.675	2.575	2.426	2.279	2.183	2.087	1.993	1.899
	750	2.605	2.492	2.324	2.159	2.051	1.944	1.838	1.734	3.190	3.070	2.894	2.720	2.605	2.492	2.380	2.269
	900	2.994	2.864	2.673	2.484	2.360	2.238	2.117	1.997	3.661	3.525	3.324	3.125	2.994	2.864	2.736	2.609
33-PKPKPKP	300	1.790	1.710	1.593	1.478	1.403	1.329	1.255	1.183	2.199	2.115	1.991	1.870	1.790	1.710	1.632	1.555
	400	2.267	2.167	2.019	1.873	1.778	1.684	1.591	1.500	2.783	2.678	2.522	2.368	2.267	2.167	2.068	1.970
	500	2.714	2.594	2.418	2.244	2.130	2.018	1.907	1.797	3.331	3.205	3.018	2.835	2.714	2.594	2.476	2.359
	600	3.139	3.001	2.797	2.597	2.465	2.335	2.207	2.081	3.850	3.705	3.490	3.278	3.139	3.001	2.864	2.730
	750	3.734	3.570	3.329	3.091	2.935	2.781	2.629	2.479	4.577	4.405	4.150	3.899	3.734	3.570	3.409	3.249
	900	4.289	4.102	3.825	3.553	3.374	3.198	3.023	2.852	5.253	5.056	4.765	4.478	4.289	4.102	3.917	3.734

*Capacities are based on tests conducted on radiators without top grilles and side panels.

Heat output values are given for 1 m radiator length.



A salon, bedroom, living room, child's room, kitchen, bath or office... All details have been considered in the careful search for an attractive decor that suits your personal taste and provides full comfort as well. From the picture on the wall to the carpet on the floor and the style of the arm chairs-every selection is important. In such a setting there is yet another, equally important selection to be made;

The Radiator.



Chic and Decorative:

Alarko steel panel radiators lend a chic and decorative aspect to the environment in which they are placed.

Elegant: Alarko steel panel radiators offer an elegance that is indispensable among those who know how to appreciate it.



Different: Alarko steel panel radiators are selected by discriminating people. This line is indeed extraordinary, a point not so easily reached-even by those who desire it!



Quality: Alarko steel panel radiators are produced and coated according to the latest technology on computer-controlled assembly lines. These highly efficient radiators are resistant to corrosion, chemicals, impact, scratches and ambient air conditions. The smooth surfaces don't collect dust, and the special covering system allows for easy cleaning.



Multiple adaptations: Alarko steel panel radiators, with their perfect designs and up-to-date production technology, are the excellent choice for use in multi-story buildings in which high operation pressure is required.

The various alternative sizes available and their compactness also make them suitable for smaller environments.

Alarko steel panel radiators can also be supplied with compact valve ensuring piping connection from the bottom side. This type of radiator provides savings in heating costs, when equipped with a thermostatic regulator.

They sparkle: Alarko steel panel radiators add sparkle to their environment.

NEW PATENTED PACKAGING TECHNOLOGY



SAFE PACKAGING

Alarko steel panel radiators are protected from exterior effects and impurities during transportation and installation by the merit of safe packaging.



- 1- Shrinking foil
- 2- Bubble wrap foil
- 3- Corner protective plastic
- 4- Side panel protective cardboard
- 5- Label



Alarko steel panel radiators are produced in series and complying with DIN EN 442 through the high-tech computer controlled modern production lines established by Alarko Steel Panel Radiator Production Plant. The dies which are used in the production were prepared in Germany. Welding lines and test pool were designed in Switzerland. Surface preparation, coating and painting facilities have the most recent technology. The main casing of radiators is produced from cold rolled steel in conformity with EN standards.

PERFECT PAINT, LONG LIFE

Alarko steel panel radiators are resistant to corrosion, exterior effects and impacts. Their outer appearances are perfect. They have long life. Because the inner and outer surfaces of radiators are completely cleaned by applying the operations of immersion and spray oil taking, iron phosphate coating and passivation respectively in conformity with DIN 55900 and completely purified from chemical substances which effect the quality of paint. Radiators which are primer coated by the immersion method and baked are rebaked by being painted with the method of electrostatic powder-coating through robot spray in a climatized cabin.

In addition to standard panel radiator tests, Alarko panel radiators are tested to moisture conditions in humidity cabins in

conformity with EN 442.

Plus, radiators are tested under more corrosive salty water test condition. Thus, both the lifetime and quality of surface and painting operations, and resistance against moist conditions are tested.

DURABLE, IMPERMEABLE

In standard production radiators leaving the production line are individually controlled in the special test tank under the pressure of 10 bars, allowing a maximum operating pressure of 7,7 bars. Allowed maximum operating temperature is 120°C.

EASY INSTALLATION

Alarko steel panel radiators are preferred and recommended by assembly workers due to their sensitive sizes, slightness and mountability without unpacking.



The right to amend specifications under technologic developments is reserved.

ALARKO



ALARKO CARRIER
SANAYİ VE TİCARET A.Ş.

GOSB-Gebze Organize Sanayi Bölgesi
Şahabettin Bilgisu Cad. 41480 Gebze-Kocaeli/TURKEY

Phone : (90)(262) 648 60 00 PBX

Telefax : (90)(262) 648 61 01

web : www.alarko-carrier.com.tr

e-mail : info@alarko-carrier.com.tr

